

# The Avian Embryo

The earliest stages of a bird in its egg are amazing and exciting. In only three weeks, a small clump of cells that do not seem to resemble any animal species changes into an active, newly hatched chick. A study of this change is educational and interesting and gives us insight into how humans are formed.

This publication will help you study the formation of the egg and the avian (bird) embryo, or chick within the egg. This publication includes plans for two small incubators so you can build one. You may buy small, commercially built incubators at stores selling farm and educational supplies.

Incubation procedures show you the effects of heat, moisture, and ventilation on the development of the chick embryo. You also learn to hatch other fowl

such as turkeys, ducks, quail, and pheasants. This publication describes how to observe and exhibit an avian embryo while it is alive and still functioning or as a preserved specimen.

## Formation and Parts of the Egg

The avian egg, in all its complexity, is still a mystery. A highly complex reproductive cell, it is essentially a tiny center of life (Figure 1). Initial development of the embryo takes place in the blastoderm. Albumen surrounds the yolk and protects this potential life. The blastoderm is an elastic, shock-absorbing semi-solid with a high water content. Together, the yolk and albumen are prepared to sustain life—the life of a growing embryo—for three weeks, in the case of the chicken. This entire mass is surrounded by two

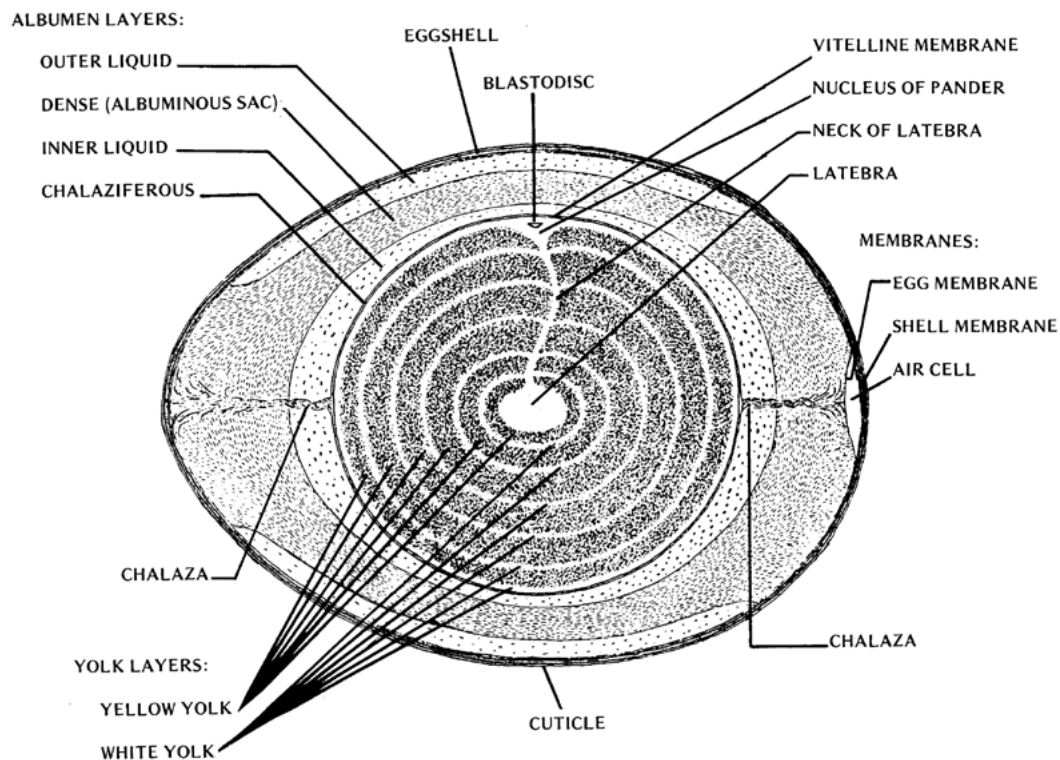

Figure 1. Structure of the hen's egg shown by a section through the long axis.

membranes and an outer covering called the shell. The shell allows an exchange of gases and is a way to conserve the food and water supply within.

A hen can produce an egg without mating. Such an egg, while edible, is not fertile and will not hatch. If a rooster mates with and fertilizes the hen, the male reproductive cell (sperm) unites with the female reproductive cell (ovum) to form a single cell that can develop into an embryo. This egg is fertile and can hatch. If you open an egg and place it in a dish, you can see a light round spot on top of the yolk. This is the germinal disc, true ova, or female egg. At the time of lay, it is hard to tell whether it is fertile.

The egg is formed in the mature hen by a reproductive system composed of an ovary and oviduct (Figure 2). Most females have two functional ovaries, but chickens and most other birds have only one ovary and one oviduct. In early states of embryonic

development, each female chick has two ovaries; only the left one develops into a functional organ. In some birds, such as hawks, the right ovary and oviduct usually develop. A mature ovary looks like a cluster of grapes. It may contain up to 4,000 small ova that can develop into yolks. Each yolk is attached to the ovary by a slender stem or peduncle. It is encased by a thin membrane sac or follicle having a fine network of blood vessels.

The oviduct is a large, coiled tube located in the left side of the abdominal cavity. In this oviduct, all parts of the egg except the yolk are formed. It is divided into five distinct regions:

- ▶ infundibulum or funnel
- ▶ magnum
- ▶ isthmus
- ▶ uterus or shell gland
- ▶ vagina

Each male chicken has two reproductive organs called testes, located within the body about midway of the back. The testes produce sperm cells that are complementary to the egg cells of the hen. Each sperm cell has a long, whip-like tail that propels it forward. The sperm are sent to the cloaca through the vas deferens, a tube between the testes and cloaca. After mating, the sperm travel through the hen's oviduct and concentrate in storage sites of the infundibulum.

The yolk is formed in the follicular sac by the depositing of continuous layers of yolk material. Ninety-nine percent of the yolk material is formed within the 7 to 9 days before the laying of the egg. The germinal disc of a developing yolk contains the single ovum cell, which, after fertilization, develops into the chick. The germinal disc remains on the surface of the yolk throughout yolk formation.

When the yolk matures, the follicular sac ruptures or splits along a line with few, if any, blood vessels. This line is called the stigma. If any blood vessels cross the stigma, a small drop of blood may be deposited on the yolk as it is released from the follicle. This causes most blood spots in eggs. After the yolk is released from

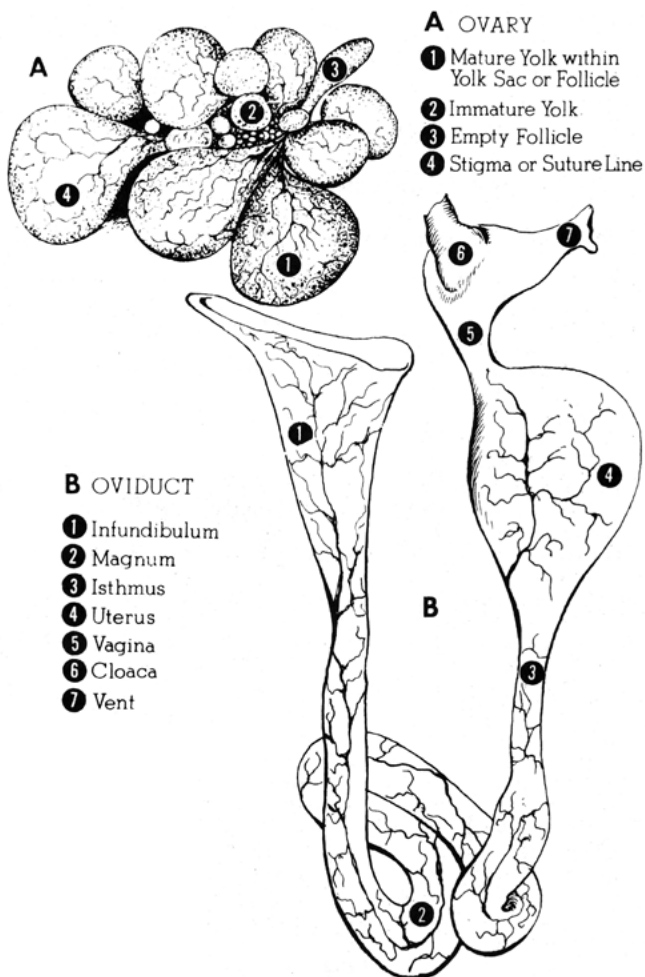

Figure 2. Enlarged drawing of an ovary and oviduct.

the follicle, it is kept intact by the vitelline membrane surrounding it. The release of the yolk from the ovary is called ovulation.

After its release from the follicle, the yolk falls into the hen's abdominal cavity. The infundibulum of the oviduct quickly engulfs the yolk with its thin, funnel-like lips. If, for some reason, the infundibulum is unable to pick up the yolk from the body cavity, the body will reabsorb the yolk. A hen that consistently fails to pick up the yolks from the body cavity is called an internal layer.

After the yolk is surrounded by the infundibulum, fertilization of the ovum follows almost immediately. Sperm cells from the male are stored in glands or nests located in the infundibulum and are released when the yolk passes by. A sperm cell must penetrate the thin vitelline membrane and reach the female cell to complete fertilization. The vitelline membrane thickens as the rest of the egg is formed.

The yolk quickly enters the magnum section of the oviduct, where the dense portion of the albumen is added. The albumen serves as a shock-absorbing substance and feeds the developing embryo. The shape of the egg is largely determined in this section.

The magnum is divided from the isthmus by a narrow, translucent ring without glands. The isthmus is smaller in diameter than the magnum. It is here the two shell membranes form. The shell membranes loosely contain the yolk and dense white until the rest of the albumen is added in the uterus.

The shell is added in the uterus or shell gland portion of the oviduct. The shell is composed mainly of calcium carbonate. It takes about 20 hours for the eggshell to form. If the hen lays brown eggs, the brown pigments are added to the shell in the last hours of shell formation.

The chalazae—two cord-like structures that keep the yolk centered in the egg—first appear in the uterus. The chalazae also function as an axis around which the yolk can rotate and keep the germinal disc uppermost at all times.

In the last portion of the oviduct, the vagina, a thin coating called bloom is applied to the shell to keep harmful bacteria or dust from entering the eggshell pores. The egg passes through the oviduct small end first but is laid large end first. In the vagina, the egg is turned horizontally just before laying. If the hen is disturbed on the nest, the egg may be prematurely laid small end first. Oviposition is the act of pushing the egg from the oviduct.

When an egg is laid, it fills the shell. As it cools, the inner portion of the egg contracts and forms an air cell between the two shell membranes. A high-quality egg has a tiny air cell, indicating the egg was collected soon after being laid and was stored properly. The air cell is usually located in the large end of the egg, where the shell is most porous and air can enter easily. The chick punctures and breathes through this air cell just before hatching.

## **Life in 21 Days**

One of the greatest miracles of nature is the transformation of the egg into the chick. A chick emerges after a brief 3 weeks of incubation. The complexity of the development cannot be understood without some explanation of embryology.

Cell division begins soon after fertilization, even while the rest of the egg is being formed. Cell division will continue if the egg is kept warmer than 80°F. The first cell division is completed about the time the egg enters the isthmus. Additional cell divisions take place about every 20 minutes, so by the time of lay, several thousand cells form two layers of cells called a gastrula.

At this time, the egg is laid, it cools, and embryonic development usually stops until proper environmental conditions are reestablished for incubation. After incubation begins, cellular growth resumes. At first, all the cells are alike, but as the embryo develops, you can see cell differences. Some cells may become vital organs; others become a wing or leg.

Soon after incubation is begun, a pointed, thickened layer of cells becomes visible in the caudal or tail end of the embryo. This pointed area is the primitive streak and is the longitudinal axis of the embryo.

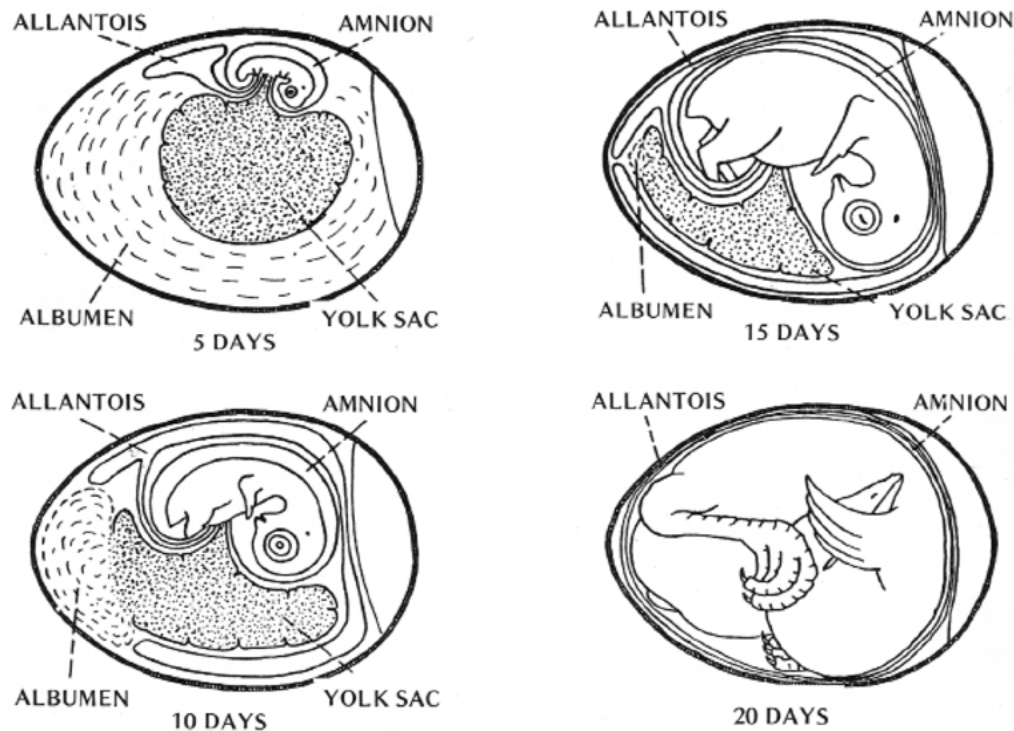

Figure 3. Allantois, amnion, albumen, and yolk sac development at 5, 10, 15, and 20 days.

Before the first day of incubation is through, many new organs are forming. The head of the embryo becomes distinguishable; a precursor of the digestive tract, the foregut, is formed; blood islands appear and will develop later into the vascular or blood system; the neural fold forms and will develop into the neural groove; and the eye begins.

On the second day of incubation, the blood islands begin linking and form a vascular system, while the heart is being formed elsewhere. By the 44th hour of incubation, the heart and vascular systems join, and the heart begins beating. Two distinct circulatory systems are established—an embryonic system for the embryo and a vitelline system extending into the egg.

In later stages of embryonic development, there are two distinct extra-embryonic blood systems. One system, the vitelline system, transports nutrients from the yolk to the growing embryo. Before the fourth day, it oxygenates the blood. The other blood system, made of allantoic vessels, is concerned with respiration and the storage of waste products in the allantois. When the chick hatches, both circulatory systems cease to function.

On the second day, the neural groove forms and the head portion develops into the parts of the brain. The embryo is developed enough that flexion and arching of the embryo begins, the ears begin development, and the lenses in the eyes begin to form.

At the end of the third day of incubation, the beak begins developing, and limb buds for the wings and legs are seen. Three visceral clefts (gills) have formed on each side of the head and neck. These formations are important in the development of the arterial system, eustachian tube (in the ear), face, jaw, and some ductless glands. The fluid-filled amnion has surrounded the embryo to protect it: it helps maintain proper embryonic development. The tail appears, and the allantois is seen. The allantoic vesicle is a respiratory and excretory organ. Nourishment from the albumen and calcium from the shell are transported to the embryo through the allantois.

Torsion and flexion continue through the fourth day. The chick's entire body turns 90 degrees and lies down with its left side on the yolk. The head and tail come close together so the embryo forms a C shape. The mouth, tongue, and nasal pits develop as parts

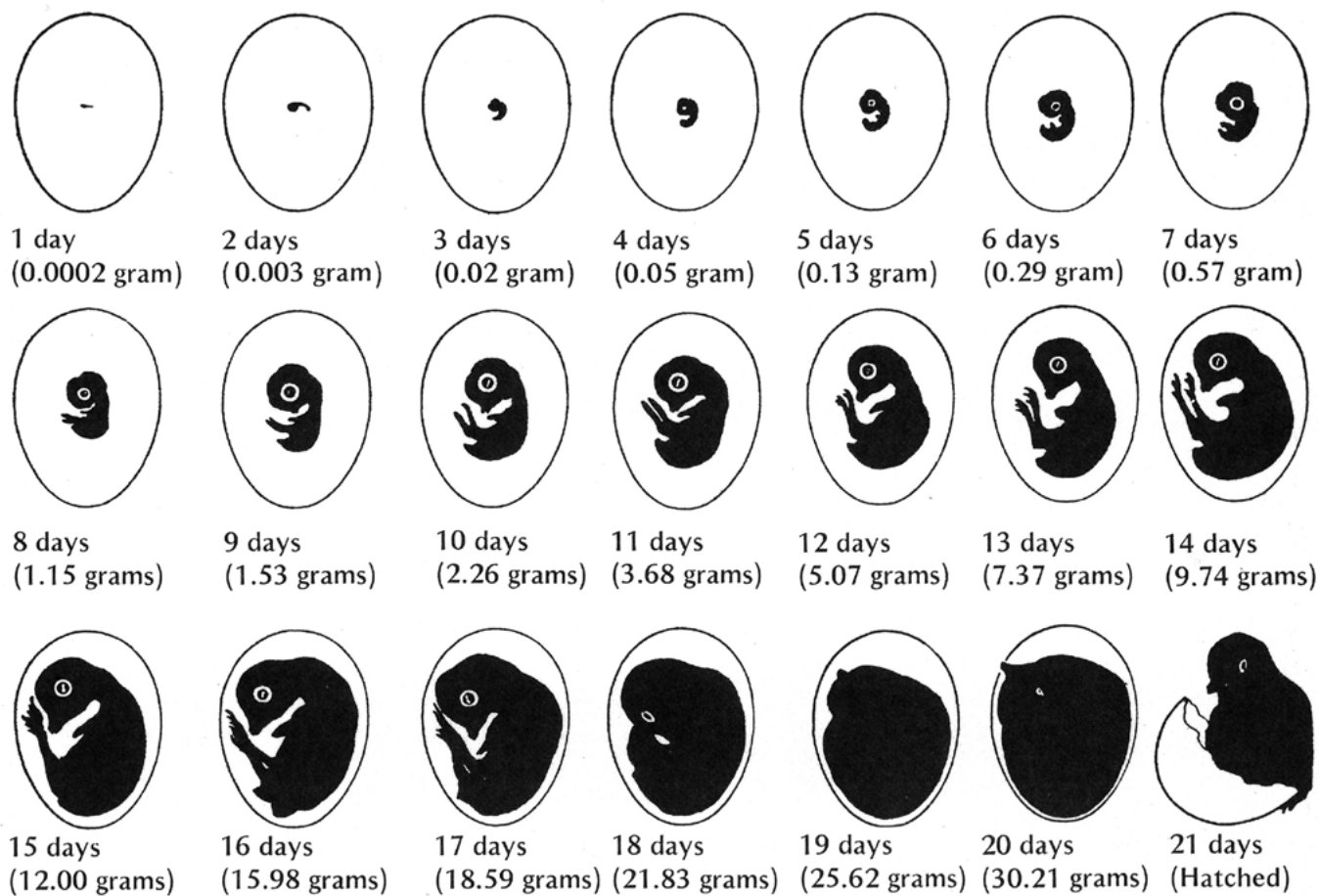

Figure 4. The embryo grows and develops rapidly.

of the digestive and respiratory systems. The heart continues to enlarge, even though it has not been enclosed within the body. It is seen beating if the egg is opened carefully. The other internal organs continue to develop. By the end of the fourth day of incubation, the embryo has all organs needed to sustain life after hatching, and most of the embryo's parts can be identified. The chick embryo cannot, however, be distinguished from that of mammals.

Many complex physiological processes take place during the change from egg to chick. They include the use of highly nutritious food materials in the egg and the respiration of gases (taking in oxygen and removing carbon dioxide and building living energy within the chick).

The embryo grows and develops rapidly (Figures 3 and 4). By the seventh day, digits appear on the wings and feet, the heart is completely enclosed in the thoracic cavity, and the embryo looks more like a bird. After the 10th day of incubation, feathers and

feather tracts are visible and the beak hardens. On the 14th day, the claws are forming and the embryo is moving into position for hatching. The supply of albumen is exhausted by the 16th day, so the yolk is the sole source of nutrients. After 20 days, the chick is in the hatching position, the beak has pierced the air cell, and pulmonary respiration has begun. The yolk sac is contained completely within the body cavity in preparation for hatching.

The normal position of the chick for hatching is with the head in the large end of the egg, under the right wing, with the legs drawn up toward the head. If the head is positioned in the small end of the egg, the chick's chances of survival are reduced by at least half. This is a serious malposition, or wrong position, for hatching. Just as a wrong position makes birth more difficult in mammals, a wrong position of the chick makes hatching more difficult or impossible.

After 21 days of incubation, the chick finally begins its escape from the shell. The chick begins by pushing

its beak through the air cell. The allantois, which has served as its lungs, begins to dry up as the chick uses its own lungs. The chick continues to push its head outward. The sharp horny structure on the upper beak (egg tooth) and the muscle on the back of the neck help cut the shell. The chick rests, changes position, and keeps cutting until its head falls free of the opened shell. It then kicks free of the bottom portion of the shell. The chick is exhausted and rests while the navel openings heal and its down dries. Gradually it regains strength and walks. The incubation and hatching are

complete. The horny cap will fall off the beak within days after the chick hatches.

Newly hatched chicks can be shipped long distances (up to 72 hours travel time) without food. You must provide chicks with feed and water on the first day of life so they can learn to eat and drink immediately. The yolk is largely unused by the embryo and is deposited within the chick's body on the 19th day, just before it hatches. The yolk is highly nourishing and provides proteins, fats, vitamins, minerals, and water for several hours after hatching. The yolk is consumed gradually during the first 10 days of the chick's life.

---

## Events in Embryonic Development

### *Before Egg Laying*

- ▶ Fertilization
- ▶ Division and growth of living cells
- ▶ Segregation of cells into groups of special function (tissues)

### *Between Laying and Incubation*

- ▶ No growth; stage of inactive embryonic life

### *During Incubation*

#### **First day**

- ▶ 16 hours—first sign of resemblance to a chick embryo
- ▶ 18 hours—appearance of alimentary tract
- ▶ 20 hours—appearance of vertebral column
- ▶ 21 hours—beginning of nervous system
- ▶ 22 hours—beginning of head
- ▶ 24 hours—beginning of eye

#### **Second day**

- ▶ 25 hours—beginning of heart
- ▶ 35 hours—beginning of ear
- ▶ 42 hours—heart beats

#### **Third day**

- ▶ 60 hours—beginning of nose
- ▶ 62 hours—beginning of legs
- ▶ 64 hours—beginning of wings

#### **Fourth day**

- ▶ beginning of tongue

#### **Fifth day**

- ▶ formation of reproductive organs and differentiation of sex

#### **Sixth day**

- ▶ beginning of beak

#### **Eighth day**

- ▶ beginning of feathers

#### **Tenth day**

- ▶ beginning of hardening of beak

#### **Thirteenth day**

- ▶ appearance of scales and claws

#### **Fourteenth day**

- ▶ embryo gets into position suitable for breaking shell

#### **Sixteenth day**

- ▶ scales, claws, and beak becoming firm and horny

### **Seventeenth day**

- ▶ beak turns toward air cell

### **Nineteenth day**

- ▶ yolk sac begins to enter body cavity

### **Twentieth day**

- ▶ yolk sac completely drawn into body cavity; embryo occupies practically all the space within the egg except the air cell

### **Twenty-first day**

- ▶ hatching of chick

*From A.L. Romanoff, Cornell University Extension Bulletin 205.*

## **Incubating and Hatching Chicks**

### ***Getting and Caring for Hatching Eggs***

In urban areas, getting hatching eggs may be a problem. Remember: eggs purchased from your local grocery store are not fertile and will not hatch. Egg producers supplying the stores with market eggs do not keep roosters with hens.

You can buy hatching eggs from most poultry breeding farms. For a list of hatching egg sources, contact your local Extension office. If possible, go to the farm and bring the eggs home yourself rather than having them shipped or mailed. It is difficult for the post office or transport companies to provide proper shipping conditions for small orders of hatching eggs.

Often, careful attention is given to incubating and rearing chicks, but none is given to the care of the eggs before incubation. As we learned earlier, embryo development occurs even before the egg is laid. The best hatching eggs will suffer from reduced hatchability unless provided with proper care between oviposition and incubation.

It may not be practical for you to place the eggs in an incubator as soon as you get them. If not, keep them in a cool, humid room. The best storage conditions are near 55°F with 75 percent humidity. The vegetable section of your refrigerator is a suitable

area. The temperature should not drop below 40°F, or hatchability will be reduced. The cool temperature will delay embryonic growth until incubation begins, and the high humidity will keep the eggs from drying out.

Incubate the eggs as soon as possible to prevent a reduction in hatchability. The hatchability of eggs older than 7 to 10 days decreases rapidly; at 3 weeks it reaches zero percent. If the eggs are not incubated within 3 to 4 days, turn them daily. Turning the eggs prevents the yolks from touching the shell and injuring the embryo. Plan ahead to avoid storage problems and reduced hatches.

Don't save excessively dirty eggs for hatching. These eggs can contaminate other eggs or chicks. Clean slightly soiled eggs by sanding them lightly with fine sandpaper. Don't sand them hard enough to make the shell thin or weak. Never wash hatching eggs, because this forces bacteria through the shell and into the egg.

The eggs should warm to room temperature before being placed in the incubator. The shock of warming the eggs too rapidly will cause moisture to condense on the shell; this may lead to disease or a reduced hatch.

### ***Incubation Procedures***

Because the incubator is not well insulated and will be opened frequently when the eggs are turned, keep the machine in a room where the temperature is between 70 and 75°F. (Normal room temperatures are satisfactory.) Do not place the incubator near windows where it may be exposed to the direct rays of the sun or near cold walls.

Two basic types of incubators are available: forced-air and still-air incubators. In forced-air incubators, fans provide internal circulation. The capacity of these units may be large. The still-air incubators are usually small and have no fans for air circulation. Air exchange is made by escaping warm, stale air at the top and entering cooler, fresh air at the bottom. Recommended temperature will vary between the two incubators, so follow the manufacturer's recommendations. All references to incubators are directed to the still-air incubators except where noted.

Clean and disinfect the incubator before each use. Wash the unit with a warm detergent solution and rinse with a disinfectant solution. This reduces the chances of carrying disease-causing organisms from one batch of eggs to another.

Start the incubator a day or two before setting the eggs. Turn on the heat and place water in the tray so you will have proper incubation conditions. Place a thermometer in the incubator so the bulb is 1 inch above the screen floor, close the incubator, and adjust the thermostat until the temperature stays between 101 and 102°F. Be careful that the bulb of the thermometer does not touch the eggs or the side of the incubator. The sides and top of the incubator should fit together securely to prevent heat loss.

To get the best possible hatch, keep the temperature as close to 102°F as possible for the complete incubation period. There will be minor fluctuations of 1 degree above and below the desired temperature, but there should not be prolonged periods of high or low temperatures. Hatching eggs can take an amazing amount of abuse because they are well protected and insulated, but they are sensitive to extreme heat. Operating the incubator at 105°F for 30 minutes will harm many embryos, but operating at 90°F for 3 to 4 hours will merely slow the rate of growth.

Check the thermometer! Is it accurate? An error of 1 degree for 21 days can seriously interfere with an embryo's growth. To check the incubator thermometer, place the bulb next to the bulb of a clinical (oral kind used to check body temperature) or a laboratory thermometer. Hold them under lukewarm water and compare the readings. Both should read the same temperature, so make adjustments for any error in the incubator thermometer. A thermometer in which the mercury column is separated will not give an accurate reading. Discard it.

Humidity must be carefully controlled to prevent unnecessary moisture loss from the eggs. A device often used to measure humidity inside an incubator is the hygrometer. Readings from a hygrometer are measured in "degrees, wet bulb." Use Table 1 to convert hygrometer readings to relative humidity.

**Table 1. Wet bulb vs. relative humidity.**

Relative Humidity	Wet Bulb at 99 °F	Wet Bulb at 100 °F	Wet Bulb at 101 °F	Wet Bulb at 102 °F
45	80.5	81.3	82.2	83.0
50	82.5	83.3	84.2	85.0
55	84.5	85.3	86.2	87.0
60	86.5	87.3	88.2	89.0
65	88.0	89.0	90.0	91.0
70	89.7	90.7	91.7	92.7

The relative humidity in the incubator for the first 18 days should remain at 58–60 percent of 87 to 89°F, wet bulb. Increase the humidity during the last 3 days of incubation to at least 65 percent relative humidity or 90 to 94°F, wet bulb.

An excellent way to determine if proper humidity is maintained is to candle the eggs. Figure 5 shows the normal size of the air cell after 7, 14, and 18 days of incubation. As incubation progresses, the air cell of the egg becomes larger because moisture is lost from the egg. You can make necessary humidity adjustments as a result of the candling inspection.

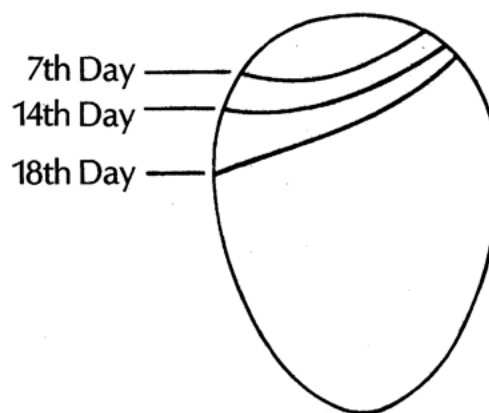

**Figure 5. Size of air cell in the egg on the seventh, fourteenth, and eighteenth days of incubation.**

Rarely is the humidity too high in a still-air incubator. The water pan should cover at least one-half of the surface area of a still-air incubator. At hatching time, place another pan of water or a wet sponge in the incubator to increase the humidity by increasing the exposed water surface area. Chicks need to be saturated before they can hatch properly, but do not drown them. High humidity will produce a late hatch; low humidity will produce an early hatch. Low humidity will also cause the chick to stick in the shell and die at hatching time.



Proper ventilation is vital. During embryonic development, oxygen enters the egg through pores in the shell, and carbon dioxide escapes in the same manner. As the chicks begin to hatch, they must receive an increasing supply of fresh air. As the embryos grow, gradually open the air openings of the incubator to increase the airflow. Be sure to avoid reducing the humidity during the hatching period. Provide ventilation openings both above and below the eggs for proper air exchange. Never place more than one layer of eggs in a still-air incubator.

If the electric power fails, the eggs will fare best if left alone to conserve the heat and humidity within the incubator. If the incubator is the forced-air type, open the incubator immediately and let fresh air enter. Maintain the room temperature at 75°F or more.

Turn the eggs at least two or three times daily during the first 18 days of incubation. Turning keeps the embryo from sticking to the shell membranes. DO NOT turn eggs during the last 3 days before hatching. The embryos are moving into hatching position and do not need to be turned.

An excellent method to tell if all eggs have been turned is to mark an X on one side of the shell and an O on the opposite side. You can always tell if the eggs have been turned by noting which side is up. Write the marks with a pencil so harmful chemicals do not enter the eggs. When turning, be sure your hands are clean and free of greasy or dusty substances. During the first week of incubation, turn eggs carefully because the developing embryos have delicate blood vessels that may be ruptured if jarred or shaken.

Mark eggs incubated on different days with the date you placed them in the incubator. This prevents eggs from being overlooked and left in the incubator after they should have hatched. The eggs should be set and maintained vertically with the large end up or horizontally with the large end slightly elevated. This will let the embryo stay in the proper position for hatching.

Chicken eggs require 21 days to hatch, but the incubation periods for the eggs of other species of poultry vary. Table 2 shows the approximate periods

**Table 2. Approximate incubation periods for different poultry and game bird species.**

Bird	Days
Chicken	21
Turkey	28
Duck	28
Muscovy duck	33–35
Goose	29–31
Guinea	26–28
Pigeon	16–18
Ring-neck pheasant	23–24
Bobwhite quail	23
Japanese quail	17–18
Chukar partridge	22–23
Peafowl	28

of incubation required for various species of poultry and game birds.

Don't disturb the eggs during the three days before hatching. Place adequate water in the incubator and make necessary adjustments before closing the incubator on the 18th day. Don't open the incubator until all chicks have hatched. Opening the incubator allows moisture to escape and makes it more difficult for the chicks to hatch. All the chicks should be out of their shells by the end of the 21st day unless you did not maintain proper incubation conditions. Chicks hatched after the 22nd day are not healthy and vigorous. After the chicks have hatched and fluffed up, remove them from the incubator and place them under a brooder with feed and water.

When the hatch is completed, disconnect the incubator and remove all chicks, shells, and unhatched eggs. Wash the interior of the incubator with a warm detergent solution. If the incubator is to be used immediately, rinse it with a disinfectant solution. After the incubator has dried thoroughly, store it for later use.

### ***Constructing an Egg Incubator***

You can buy small incubators, suitable for use in the home, from stores that sell farm equipment. You can build an egg incubator at home with a little work and small expense. This publication contains plans for two still-air incubators.

The first incubator is constructed from a Styrofoam ice chest. It is inexpensive, and because it is insulated, it is inexpensive to operate. It can be damaged easily. You can observe the eggs and chicks through a window in the lid. This incubator will hold about 40 to 45 eggs.

The second incubator is more expensive but is more permanent. It is constructed of plywood and glass and will accommodate up to 100 large eggs. Both incubators are heated by a commercially available heating cable. You can replace the heating cable with two or three ordinary light bulbs. Get a list of organizations that sell incubator supplies and equipment from your local Extension office.

### *Styrofoam Incubator*

#### **Materials Needed**

- ▶ Styrofoam ice chest (12–16 by 20–24 by 12–15 inches)
- ▶ Heating cable
- ▶ Micro-switch assembly (thermostat)
- ▶ Glass (approximately 10 by 14 inches)
- ▶ One-quarter-inch welded wire hardware cloth (24 by 36 inches)
- ▶ Cake tin (9 by 14 by 1.5 inches)
- ▶ Thermometer
- ▶ Masking tape

Get all equipment and supplies before starting construction. Carefully read and understand the instructions. Expect to spend about 2 hours building the incubator and 4 hours testing it.

Begin construction on the platform for the eggs. Cut the welded wire or hardware cloth so it is 6 inches longer and 6 inches wider than the inside bottom of the ice chest. Cut a 3-inch square from each corner and bend the projecting pieces at right angles to form legs for the platform. Remove any rough edges and cover the cut edges with tape. Install the cake pan and the platform in the bottom of the chest.

Then install the heating element and micro-switch assembly. Protect the Styrofoam sides from the heating

element by placing masking tape or similar material around the interior of the chest. Place one strip of tape 2½ inches from the top. Place one strip 1 inch above the platform and another strip midway between the top and bottom strips.

Position the micro-switch assembly on one of the end walls so the center hole is about 5 inches below the top of the chest. With a pencil or other sharp pointed tool, make three holes in the chest for the temperature control bolt and two mounting bolts. Mount the switch by inserting the mounting bolt, adding the washers, and tightening the nuts until the unit is firmly attached. Insert the heating cable plug and the pilot light into the switch assembly before plugging in the lead cord. Check the unit to see if the pilot light glows and the heating cable warms up when you activate the switch. Both should be off when you turn off the switch. After checking the unit, remove the lead cord from the electrical outlet.

Fasten the midpoint of the cable to the top strip of tape at the opposite end of the chest. Using tape, fasten the remainder of the cable to the top and bottom strips of tape alternately while forming serpentine loops. The cable does not need to be fastened to the middle strip of tape. Do not allow the cable loops to touch each other.

You may install a window in the lid of the chest so you can see the eggs and chicks as they hatch. Center the piece of glass on the top of the lid and trace its outline with a marker. Remove the glass and draw a smaller rectangle inside the first with all sides parallel and three-quarters of an inch inside the traced glass rectangle. With a sharp knife, cleanly cut out the smaller rectangle and discard it. Then carefully cut around the outline of the glass on top of the lid to a depth of only one-fourth inch. Do not cut through the top.

On the cut edge made when you removed the rectangle, mark a line one-fourth inch from the top of the lid. With a sharp knife or razor, cut along the line until it meets with the cut made earlier. The strip should lift out easily to form a recessed ridge around the rectangular hole. Place the glass in the recessed area and secure it with tape.

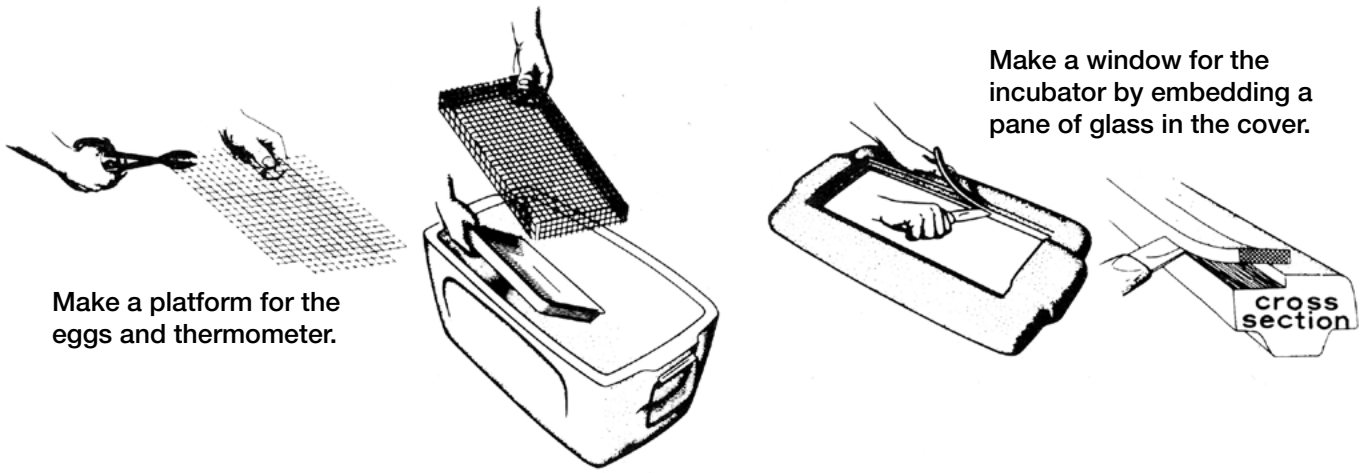

Make a platform for the eggs and thermometer.

Make a window for the incubator by embedding a pane of glass in the cover.

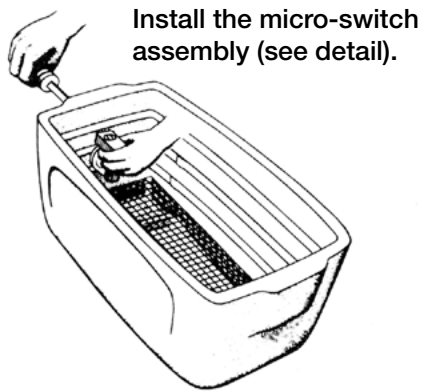

Install the micro-switch assembly (see detail).

Install the heating cable.

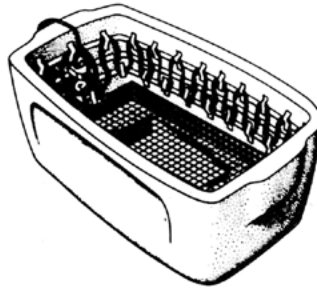

**Micro-switch Assembly**

1. Center hole
2. Convenience outlet box
3. Bolts
4. Temperature control bolt
5. Washers
6. Nuts
7. Self-locking nut
8. Ether wafer
9. Plug
10. Convenience outlet
11. Pilot light
12. Convenience outlet
13. Lead cord plug
14. Micro-switch
15. Heating cable

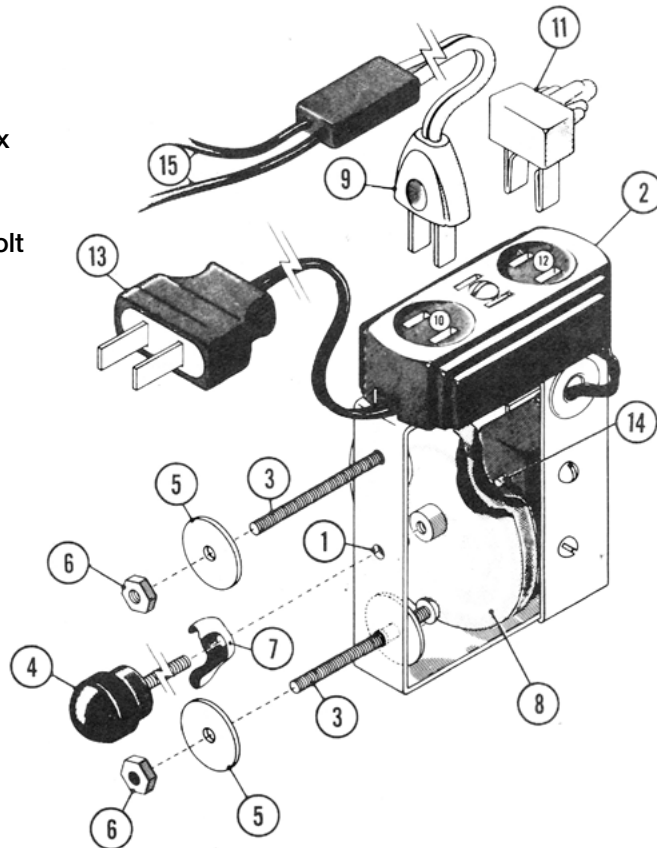

Proper ventilation is provided by sixteen one-fourth-inch holes in the sides of the chest. Make the holes with a pencil or other sharp instrument. On each of the large sides of the chest, make a row of four holes 2 inches from the bottom and another row of four holes 3 inches from the top. The holes in each row should be 4 inches apart.

Test the incubator by placing a shallow layer of warm water (100°F) in the pan. Place the thermometer on the wire platform, put the lid on the chest, and plug in the lead cord. Turn the temperature control bolt until the pilot light goes on. Frequently readjust the control bolt until the desired temperature is reached. The pilot light and heating cable should shut off. Allow the unit to operate for several hours before placing the eggs in it. This allows time to see how well the unit maintains a constant temperature.

### ***Plywood Display Incubator***

This incubator is more expensive and will take longer to construct than the Styrofoam incubator but is more durable. It is built of half-inch exterior or marine-grade plywood and glass and will accommodate up to 100 large eggs. Both incubators are heated by a commercially available glass-covered heating element. For the plywood incubator, it should provide 160 watts of heat. Slightly less heat is required in the Styrofoam incubator.

Building plans and materials for this incubator are shown on the following pages.

### **Materials Needed**

- ▶ 1 piece ½ by 4 by 6-inch A-C exterior plywood
- ▶ 5 pieces ¾-inch by ¾-inch by 8-foot pine
- ▶ 1 piece ¾-inch by 1½-inch by 13-foot pine
- ▶ 1 piece ¾-inch by ¾-inch by 4-foot pine
- ▶ 1 piece ½-inch by ¾-inch by 8-foot pine
- ▶ 1 piece ½ by 18 by 27-inch rigid insulation board
- ▶ 1 piece 18 by 27-inch heavy-duty aluminum foil
- ▶ 1 piece ½ by 30-inch semi-rigid plastic pipe
- ▶ 4 pieces 10 by 20-inch single-strength window glass
- ▶ 4 pieces 10 by 14-inch single-strength window glass
- ▶ 2 1½ inch round wooden drawer pulls
- ▶ 2 metal drawer pulls (cup type)
- ▶ 2 2-inch hooks with eyes
- ▶ 1 piece 8-foot felt weather stripping, ¼ by ½-inch
- ▶ 1 piece 20 by 27 by ¼-inch hardware cloth
- ▶ 2 vent covers (sheet metal)
- ▶ 1 incubator electrification kit composed of wafer thermostat with duplex outlet, pilot light, and service cord; and 160-watt flexible glass-covered heating element
- ▶ 1 attachment plug
- ▶ 2 feet No. 18-2 flexible rubber-covered service cord
- ▶ 1 duplex outlet for surface mounting
- ▶ 10 small porcelain knobs for mounting heating element
- ▶ 1 pair 4 by 1-inch flat hinges
- ▶ 1 water pan (minimum 360 sq. in.)
- ▶ 1 piece ⅛-inch by 16½-foot steel rod
- ▶ 1 piece ⅜-inch by 8-foot steel rod
- ▶ Assorted nails and screws
- ▶ Waterproof wood glue

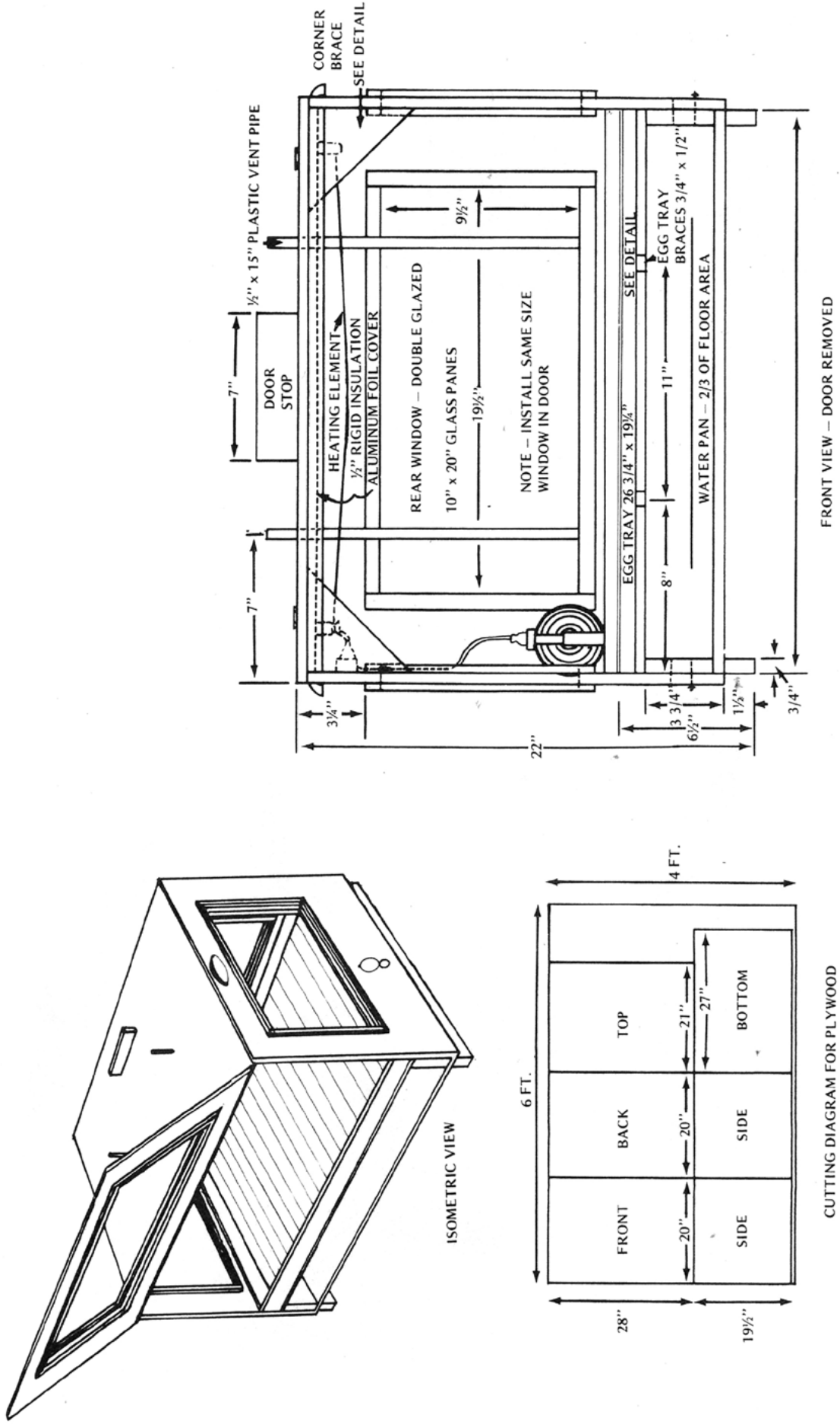

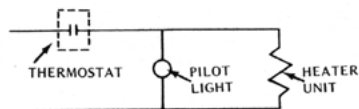
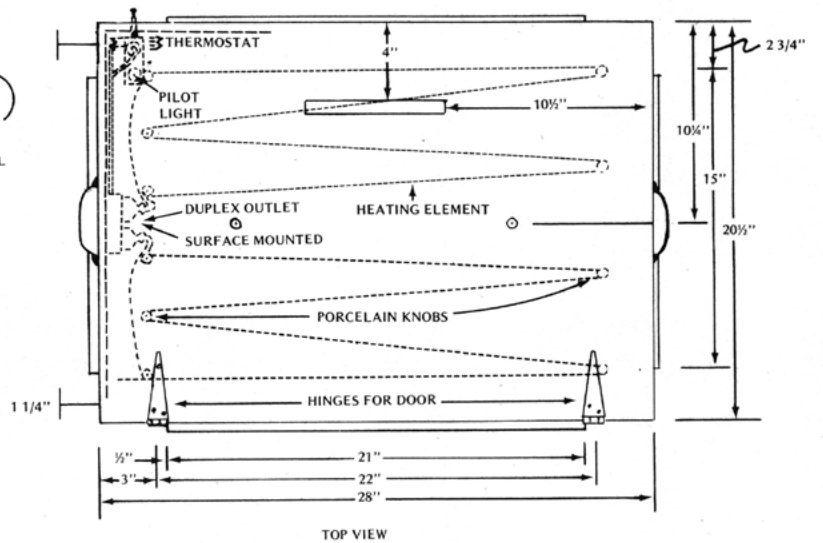
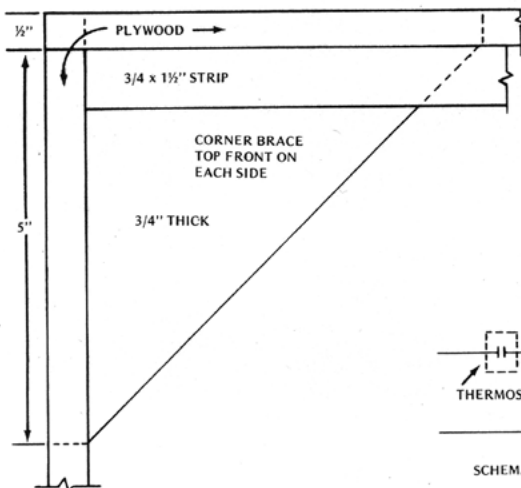
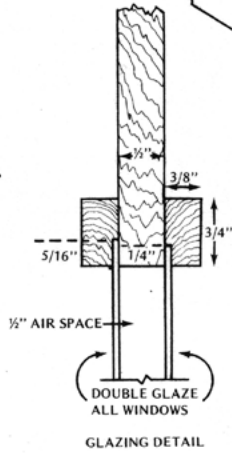
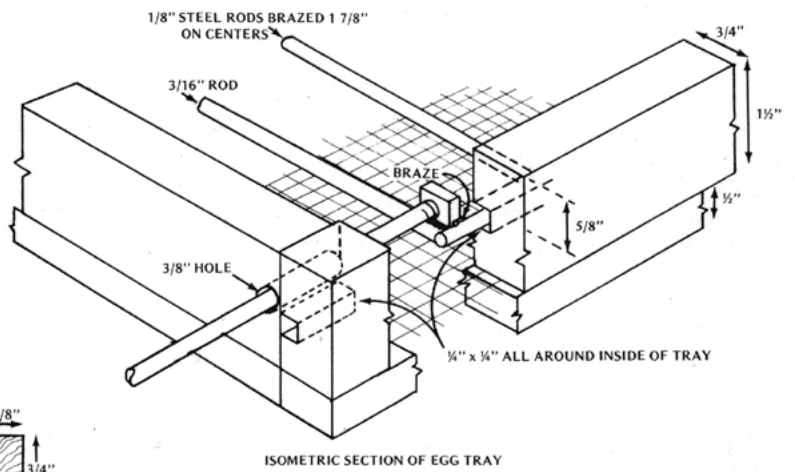
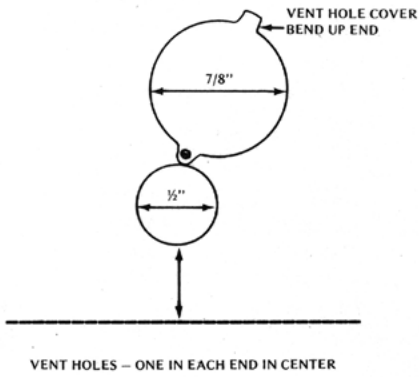
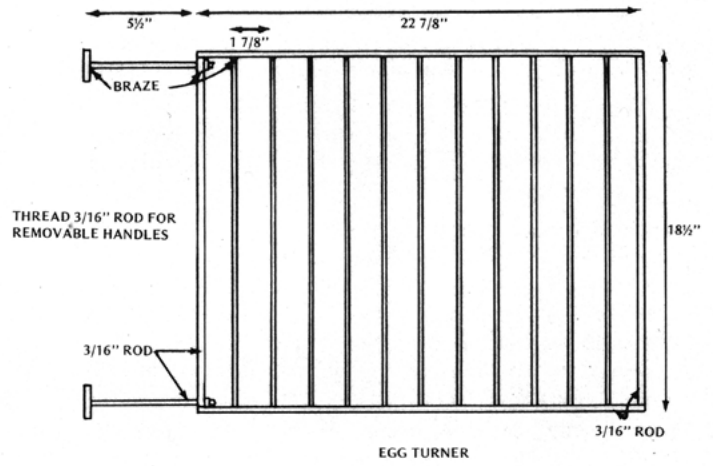
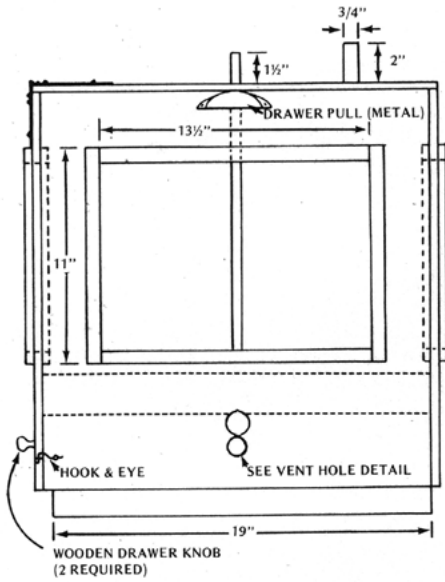

## Hatching Failures

Eggs do not hatch for reasons that may or may not be the fault of the person caring for the eggs. Below are a few common reasons for incubation failures.

- ▶ Infertile eggs. Buy fertile hatching eggs from farms having at least one rooster with every 10 hens. Avoid seasonal temperature problems by getting hatching eggs in the spring.
- ▶ Parent stock are weak, unhealthy, or fed a nutritionally deficient diet. Buy eggs from farms that care for the breeder flock by following sound poultry management practices.
- ▶ Eggs are too old or improperly cared for before incubation. Care for the eggs as described. Do not store eggs for longer than 7 to 10 days before incubating.
- ▶ Shell contamination. Incubate only clean or slightly dirty eggs cleaned with sandpaper. Do not wash dirty hatching eggs or allow eggs to sweat before placing them in the incubator.
- ▶ Temperature too high, too low, or too variable. Check incubator temperatures with an accurate thermometer, and adjust the thermostat accordingly.
- ▶ Too little or too much humidity in the incubator. Obtain a hygrometer and measure the humidity before making further adjustments.
- ▶ Eggs not turned often enough. Turn eggs at least two or three times daily. Commercial hatcheries turn eggs every 2 hours.
- ▶ Improper ventilation resulting in oxygen starvation. Be sure all ventilation holes are open in still-air incubators. Forced-air incubators should start with vent openings half-opened. Increase ventilation after 10 days until openings are fully opened at hatching time.
- ▶ Rough handling of eggs. Ordinary handling does not harm the embryo because of the protection provided by the egg and amniotic fluid. Excessive handling and jarring of eggs while turning, especially during the first week, may be harmful.

## Embryology Projects

### *Coloring Chick Embryos*

The main purposes of coloring embryos are to provide a practical method of identifying chicks from different groups of eggs and to be able to watch their movements after they leave the nest. In wildlife management studies, where identification and observation of ducks are difficult, identification and observation are made easy by coloring the embryos with bright dyes.

Coloring chick embryos provides the practice necessary to become skilled in the coloring technique while acquainting you with the tools and supplies students, researchers, and professional people use.

### Equipment and Supplies

- ▶ 1 large beaker (1000 ml) or pan
- ▶ 2 small beakers (250 ml) or water glass
- ▶ 1 hypodermic syringe
- ▶ 1 No. 20 gauge hypodermic needle
- ▶ 1 No. 3 dental drill or similar drill device
- ▶ 1-ounce bottle of tincture of merthiolate
- ▶ 1 ounce of paraffin
- ▶ 1 small bottle of each dye used in coloring the chicks. Certified food dyes of 2–3 percent concentration are available in most grocery stores.
- ▶ Fertile eggs incubated 16 or 17 days

### Procedure

Put water in the large beaker or pan and place it over heat. Loosen tops of bottles containing dye and place them upright in the small beaker or glass. The tops are loosened so the bottles of dye will not explode when heated. Put syringe, needles, and drill in the same container with the bottles of dye. Add about 1½ inches of distilled water to the small container, and place in the larger container until the water in the larger container has boiled for 20 minutes. Remove from the heat, pour the water out of the small container, and allow the contents to air dry as they cool.

At a spot about a half-inch from the small end of the egg, daub an area about 1 inch in diameter with merthiolate. Dip the tip of the dental drill in merthiolate. Rotate the drill between your fingers while gently pressing the tip against the shell in the center of the daubed area. Rotate until you make a hole in the shell.

Assemble the syringe and needle. Be sure they do not become contaminated by contact with foreign objects. Dip the needle in the merthiolate, and withdraw ½ cc. (cubic centimeter) or .5 ml. (milliliter) of dye. Insert only the tip of the needle in the hole and through the shell membranes. To prevent overflow, gently and slowly inject the dye. Remove the needle, seal the hole with paraffin, and return the egg to the incubator. Clean the syringe and needle by flushing them with distilled water each time you use a different color dye.

You can mix dyes to produce colors other than those available at local stores. You can inject them into chicken, duck, goose, and other species of eggs.

### ***Hatching Chick Exhibit***

You should set about three to four dozen fertile eggs 20 days before each date on which you are to display the hatching chicks. To assure chicks hatch at all hours on the day of the exhibit, set one-third of the day's hatch 8 hours earlier and another one-third 8 hours later than the normal setting time. A reasonable sequence of chicks should emerge from the eggs during the exhibit hours if there is reasonably good fertility and hatchability.

### ***Chick Embryo Exhibit***

The chick embryo exhibit should display only the 1-, 2-, 3-, 4-, and 5-day embryos, any one embryo from 6 to 10 days, any one embryo from 11 to 18 days, and any one embryo from 19 to 21 days. The abbreviated exhibit is preferred to the full 21-day exhibit because it requires fewer eggs, uses a smaller incubator, and shows the development of the chick embryo just as well as the 21-day exhibit. See Table 3 for an incubation schedule for a 1- to 6-day exhibit.

**Table 3. Incubation schedule for a 1- to 6-day exhibit of the embryonic development of living embryos.**

No. of days* before show	Length of Show (Days)					
	One	Two	Three	Four	Five	Six
	Eggs to Set					
18	5	8	8	8	8	8
16	0	0	5	8	8	8
14	0	0	0	0	5	8
10	5	8	11	14	16	18
6	5	8	11	14	16	18
5	5	5	5	5	5	5
4	4	6	8	10	10	10
3	4	6	8	10	10	10
2	4	6	8	10	10	10
1	4	6	8	10	10	10
1st day of show	4	4	4	4	4	4
2nd day of show	–	4	4	4	4	4
3rd day of show	–	–	4	4	4	4
4th day of show	–	–	–	4	4	4
5th day of show	–	–	–	–	4	4

\*This schedule is based on 80 percent fertility and 80 percent hatchability of fertile eggs.

### ***Displaying Living Chicken Embryos***

Learn to open incubated chicken eggs so you can see the day-by-day growth of the living embryo as it develops within the egg. This is an interesting and exciting activity in which you can observe the fascinating growth and development of a chick embryo. After you learn to open incubated eggs, you can then enjoy the pleasure of showing someone else how to observe the developing embryo.

While preparing the embryos, you will use tools similar to those doctors use when they perform delicate operations, and you will learn the scientific names of parts of the embryo common to unborn babies, even human babies. You will use your fingers and your eyes to do a delicate task that would require great care from the most experienced doctors, laboratory technicians, and research people. With practice, you will soon open the eggs with ease. Each time you open a fertile egg, see the heart beating, and



watch the tiny fetus exercising back and forth within the amniotic sac, you will marvel at the miracle of life.

## Equipment and Supplies

- ▶ Incubator
- ▶ Magnifying glass
- ▶ Incubated eggs
- ▶ Pine block pedestals ( $\frac{3}{4}$  by 2 by 2 inches with  $1\frac{1}{2}$ -inch diameter holes)
- ▶ Forceps (tweezers)
- ▶ Manicure scissors
- ▶ Paper towels or cloths
- ▶ Eye dropper

## How to Open the Incubated Egg

Refer to the illustrations of the fresh egg and embryonic membranes. Locate the parts of the egg described in the following paragraphs by referring to the material in Formation and Parts of the Egg at the beginning of this publication.

Incubate four fertile eggs for 48 hours. Crack the shell at the large (air cell) end by tapping gently with the heavy end of the forceps. Remove a few flakes of shell with the forceps. Then, using the manicure scissors and with a circular motion, cut away the shell extending above the contents of the egg. As you cut away the shell, you remove the outer shell membrane with it. The inner shell membrane is the opaque (white) membrane lying across the fluid portion of the egg. You must remove this so you may clearly see the embryo.

Place a drop of water on the inner shell membrane. Now gently pick at the moistened portion until you grasp it with the forceps. Caution: do not rupture the blood vessels or the thin membrane of the allantoic sac.

Use a circular motion while removing the membrane. If a blood vessel breaks, repeat the procedure on another egg. If you successfully uncover the membrane, the egg's contents are exposed. The yolk

is covered with a mass of blood vessels (called the vitelline circulation), and the tiny heart lies pulsating with life.

After you have removed the inner shell membrane, place the egg on a pedestal in the incubator. You must keep the eggs in the incubator except when you are preparing them for display or observation. After you place the egg on the pedestal, the embryo will soon come into position so you can see it easily through the window made by removing the shell. Use the magnifying glass to look closely at the beating heart and the first faint traces of the eye developing in the 3-day embryo.

Exposed to room temperature, the heart will beat for several hours if you place the egg in an upright position. You can cover the opening of the egg with cellophane film. Under warm incubation temperatures, the heart may pulsate for up to 15 hours or longer.

By breaking a fresh egg and an egg incubated for 1 day into dishes and then making windows in eggs incubated for 2, 3, 4, 5, and more days, you can easily follow the sequence of growth and development of the chick embryo.

## *Preservation of the Avian Embryo*

You can easily prepare a series of stages of avian embryo development. Such a series of embryos can provide a ready reference set for student use. Use specimens from 2 days to hatching for this purpose.

## Equipment and Supplies

- ▶ Alcohol, ethanol (70%), or isopropanol (70%)
- ▶ Forceps
- ▶ Glycerin
- ▶ Needles
- ▶ Formalin, 37% formaldehyde solution (not metal)
- ▶ Fertile eggs, incubated for desired length of time
- ▶ Bottles or vials with plastic screw caps
- ▶ Scissors

Crack the shell of the egg at the broad end with a sharp knife or scalpel, and pick away the pieces until you make an opening about 1 inch in diameter. Remove the outer and inner shell membranes. The embryo in the blastoderm will be uppermost. Using fine-pointed scissors, cut out a circle of blastoderm about the size of a quarter, leaving the embryo at the center. With blunt forceps, pull the embryo and adherent extra-embryonic membranes away from the yolk and albumen. Remove all membranes and sever the umbilical stalk near the body wall. Rinse well under tap water. After washing clean, place the embryo into a bottle containing 10 percent formalin. The formalin solution is made of one part of the 37 percent formaldehyde solution and nine parts of water. This solution will preserve the specimen. After a week or so, pour off the formalin solution, rinse the specimen in tap water, drop three to four drops of glycerin onto it, and place it into 70 percent alcohol as a final preservation agent. The glycerin keeps the specimen softer and the skin translucent.

Dip the top of the container into melted wax to seal against evaporation of the alcohol. Label the containers with detailed information—date, variety of embryo, name of person, and preservative.

Note: When dealing with embryos under 5 days of incubation, the following technique is helpful in harvesting the embryo. After the embryo is exposed from under the shell membranes, place about four drops of the formalin solution on the embryo. The solution coagulates the protein and makes it easier to harvest the embryo.

## Terms to Know

**Air cell**—The air space between the two shell membranes, usually in the large end of the egg.

**Allantois**—A sac-like organ of an embryo that obtains oxygen, nourishment, and calcium from the egg and in which is deposited the embryo's waste products.

**Amnion**—A sac filled with fluid that surrounds the embryo and protects it from injury.

**Avian**—Of, relating to, or characteristic to birds.

**Avian egg**—A bird egg composed of the shell, shell membranes, albumen, and yolk containing the true egg or ovum.

**Blastoderm**—A fertilized true egg.

**Blastodisc**—A true egg that has not been fertilized.

**Chalazae**—The two whitish cords attached to the yolk of an egg that hold the yolk in the center of the albumen.

**Chick tooth**—The tiny, horny projection on the top of the chick's beak that it uses to peck holes in the shell when hatching.

**Chorion**—A membrane surrounding both the yolk sac and the amnion.

**Cloaca**—The vent or common opening in birds through which the digestive, urinary, and reproductive tracts empty.

**Down**—Soft, fine, hair-like feathers on young birds.

**Egg**—The microscopic reproductive cell of the female; the true egg or ovum. Also see Avian egg.

**Embryo**—The early stage of development of the chick within the egg.

**Embryology**—The study of the formation and development of embryos.

**Extraembryonic membranes**—Membranes outside the embryo's body that provide respiration, nutrition, excretion, and protection. They include the yolk sac, amnion, allantois, and chorion.

**Fertilization**—The union of a male reproductive cell with a female reproductive cell.

**Fetus**—The chick during the later development stages in the egg.

**Follicle**—The sac that an ovum and its yolk are held in until the yolk matures and is released.

**Humidity**—Moisture in the air.

**Incubation**—The process of applying heat to eggs and causing them to hatch.

**Infundibulum**—The upper, funnel end of the oviduct that picks up the yolk after its release from the ovary.

**Isthmus**—The section of the oviduct following the magnum; it forms the inner and outer shell membranes of the egg.

**Magnum**—The section of the oviduct between the infundibulum and isthmus where the thick white of an egg is formed.

**Ovary**—The female organ that holds the true egg's cells and produces the yolks.

**Oviduct**—The female bird organ that puts the albumen, shell membranes, and shell around the yolk.

**Oviposition**—The release of an avian egg from the oviduct.

**Ovulation**—The release of a true egg or ovum from a follicle in the ovary.

**Ovum**—The female germ cell or true egg; plural form is ova.

**Pip**—To break through or peck holes in the shell by the chick.

**Primitive streak**—A vertical, opaque line where the embryo begins to grow and develop.

**Sperm**—The microscopic reproductive cell of a male; the male germ cell.

**Uterus**—The section of the oviduct next to the isthmus that secretes a portion of the albumen and all of the shell and shell pigment.

**Vagina**—The final section of the oviduct connected to the cloaca. The cuticle or "bloom" on an egg is added here before lay.

**Yolk sac**—The portion of the unused yolk drawn into the chick before hatching.

## Helpful References

The chick embryo in biological research. (1952). New York Academy of Sciences, 55(2).

Evans, C.D. (1951). A method of color marking young waterfowl. *Journal of Wildlife Management*, 15: 101–103.

Fertility and Hatchability of Chicken and Turkey Eggs. (n.d.) Edited by L.W. Taylor. John Wiley and Sons, Inc., New York.

Lillie, F.R. (1919 or 1952). *The Development of the Chick*. Henry Holt and Co., New York. pp. 1–472 or 1–624.

Lillie's *Development of the Chick*. (n.d.) Revised by H.L. Hamilton. Henry Holt Co., New York.

Needham, J. (1942). *Biochemistry and Morphogenesis*. MacMillan and Co., New York. pp. 1–785.

Needham, J. (1931). *Chemical Embryology*. MacMillan and Co., New York, pp. 1–2021.

Patten, B.M. (1952). *Embryology of the Chick*. The Blakiston Co., New York. pp. 1–228.

Romanoff, A.L. (1931). Why Some Eggs Do Not Hatch. *Cornell University Extension Bulletin* 205, (Feb. 1931). pp. 1–17.

Romanoff, A.L. (1939). From the Egg to the Chick. *Cornell Rural School Leaflet*, vol. 33, No. 1, (Sept. 1939). pp. 57–63.

Romanoff, A.L. & Romanoff, A.J. (1949). *The Avian Embryo*. John Wiley and Sons, Inc., New York. pp. 1–918.

Sturkie, P.D. (n.d.) *The Avian Physiology*. Comstock Publishing Assoc., Ithaca, New York.

Shumway, W. (n.d.) *An Introduction to Vertebrate Embryology*. John Wiley and Sons, Inc., New York.

*Some of these publications are in your local public, school, or college libraries.*

---

Publication 1150 (POD-07-22)

Reviewed by **Jessica Wells**, PhD, Assistant Clinical/Extension Professor, Poultry Science. Written by Tom W. Smith Jr., PhD, former Extension Poultry Specialist.



Copyright 2023 by Mississippi State University. All rights reserved. This publication may be copied and distributed without alteration for nonprofit educational purposes provided that credit is given to the Mississippi State University Extension Service.

Produced by Agricultural Communications.

Mississippi State University is an equal opportunity institution. Discrimination in university employment, programs, or activities based on race, color, ethnicity, sex, pregnancy, religion, national origin, disability, age, sexual orientation, gender identity, genetic information, status as a U.S. veteran, or any other status protected by applicable law is prohibited.

Extension Service of Mississippi State University, cooperating with U.S. Department of Agriculture. Published in furtherance of Acts of Congress, May 8 and June 30, 1914. STEVE MARTIN, Interim Director